

Einbauanleitung

Installation instruction

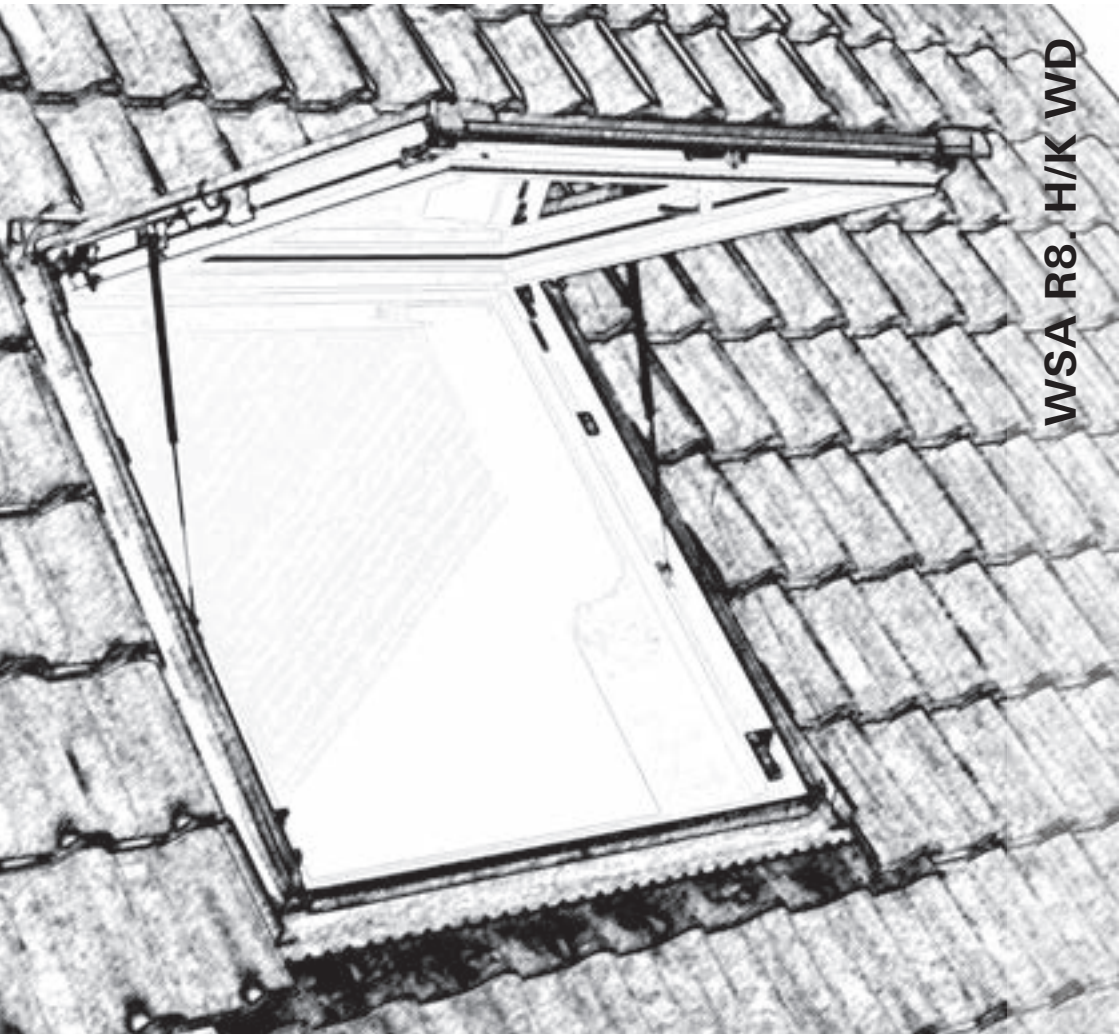

WSA R8, H/K WD

Deutschland **Hinweise/Sicherheitshinweise**

- Die allgemeinen Unfallverhütungsvorschriften bei Dacharbeiten beachten.
- Die Baustelle gegen herabfallende Teile sichern.
- Bauphysikalische Grundlagen wie Wärmedämmung, Feuchteschutz, Regensicherheit/Wasserdichtheit und Lärmschutz beachten.
- Die Zahlen geben immer die Reihenfolge der Montage an!
- Technische Änderungen vorbehalten.

 Eingriffe in Tragwerkkonstruktionen dürfen nur von qualifizierten Fachkräften ausgeführt werden!

In schneereichen Gebieten ist eine Schiefegabeinrichtung oberhalb des Fensters zu montieren.

Für Einbaulatten nur Holz der Sortierklasse S. 13 verwenden. Die Höhen der Dachlatten und die Höhe der Einbaulatten müssen gleich sein!

France **Conseil/ Recommandation de sécurité**

- Respecter le règlement général de prévention des accidents pour les travaux sur le toit.
- Assurer le chantier contre la chute de matériaux.
- Respecter les conditions de base relatives à la physique de bâtiment telles que l'isolation thermique, la protection contre l'humidité, contre la pluie/étanchéité à l'eau et protection contre le bruit.
- Les chiffres indiquent toujours l'ordre de montage !
- Sous réserve de modifications.

 Les interventions au niveau des éléments porteurs ne doivent être réalisées que par une main-d'œuvre qualifiée!

Dans les régions très enneigées, il est nécessaire de monter un dispositif d'arrêt de la neige au dessus de la fenêtre.

Pour les lattes d'installation, utiliser exclusivement du bois sans nœuds et sans fissures. L'épaisseur des liteaux et l'épaisseur des lattes d'installation doivent être identiques!

Great Britain **Safety advice/recommendations**

- Observe the general regulations for prevention of accidents concerning work on the roof.
- Secure site against falling parts.
- Observe basics of building physics, as heat insulation, protection against moisture, rain shielding/waterproofness, and noise protection.
- The numbers specify the assembly sequence.
- We reserve the right to make any amendment.

 Work on the frame structure may only be performed by qualified personnel!

For sites where high snowfall can be expected, protection or a deflector should be provided above the window.

For installation laths, use wood of the grading class MS 13/C35 only. The thickness of the roof battens and the thickness of the installation laths have to be identical!

Nederland/Belgique **Veiligheid/aandachtspunten**

- U dient bij werkzaamheden aan/op het dak de algemene voorschriften ter voorkoming van ongevallen in acht te nemen.
- U dient de bouwplaats tegen neervallende delen te beveiligen.
- U dient de bouwkundige principes zoals warmte-isolatie, vochtwering, bescherming tegen regenwater/waterdichtheid en geluidswering in acht te nemen.
- De getallen geven altijd de volgorde van de montagewerkzaamheden aan!
- Technische veranderingen voorbehouden.

 Ingrenpen in de draagconstructies mogen uitsluitend door daartoe gekwalificeerd personeel worden uitgevoerd!

In sneeuwrijke gebieden moet een sneeuwvanginrichting boven het raam worden gemonteerd.

Voor inbouwlaten mag u alleen hout van sorteerklassen S13 gebruiken. De hoogte van de daklatten en de hoogte van de inbouwlaten moeten gelijk zijn!

España **Consejo/recomendación de seguridad**

- Tenga en cuenta las prescripciones generales de prevención de accidentes para trabajos en el tejado.
- Asegure la obra contra objetos que pudieran caer.
- Tenga en cuenta los principios físicos constructivos tales como aislamiento térmico, protección contra la humedad, seguridad contra el agua y protección contra el ruido.
- Los números indican siempre el orden de montaje.
- A reserva de modificaciones.

 Cualquier modificación en los elementos estructurales debe ser realizada únicamente por personal especializado!

En zonas de grandes nevadas debe montarse un dispositivo colector de nieve por arriba de la ventana.

Utilizar únicamente madera de la clase de selección MS 13 para los listones que se desean. La altura de los listones del tejado y de los listones que se desean montar debe ser igual!

Portugal **Conselhos/recomendações de segurança**

- Cumpra com as normas gerais para a prevenção de acidentes.
- Proteja o local da construção contra a queda de quaisquer peças.
- Atenda aos princípios fundamentais fisicotécnicos da construção civil, tais como isolamento térmico, proteção anti-humidade, segurança pluvial/impermeabilidade à água e proteção contra a poluição sonora.
- Os algarismos indicam sempre a ordem da montagem!
- Sob reserva de modificações.

 A realização de toda e qualquer intervenção nos vigamentos só está autorizada a pessoal especializado devidamente qualificado!

Em zonas de muita neve, é necessário montar um dispositivo colector de neve por cima da janela.

Utilize exclusivamente madeira da classe de qualidade S 13 para as fasquias de montagem. Tanto as alturas das ripas do telhado como a altura das fasquias de montagem deverão ser idênticas!



Polka
Wskazówki/wskazówki
bezpieczeństwa

- Należy przestrzegać ogólnych przepisów bezpieczeństwa pracy przy robotach dachowych.
- Zabezpieczyć miejsce budowy przed spadającymi częściami.
- Przestrzegać przy montażu podstaw fizyki budowlanej takich jak: izolacja cieplna, ochrona przeciwwilgociowa, zabezpieczenie przed deszczem/wodoszczelność i dźwiękoszczelność.
- Cyfry podają kolejność montażu!
- Zmiany techniczne zastrzeżone.

⚠ Wszelkich ingerencji w konstrukcje nośne mogą dokonywać wyłącznie wykwalifikowani fachowcy!

W rejonach z dużymi opadami śniegu należy powyżej okna zamontować dachową barierę przeciwśniegową.

Do montażu stosować wyłącznie łąty z drewna o jakości klasy I. Grubość łąt dachowych i łąt montażowych musi być identyczna!

Rosja/ Ukraina
Указания/рекомендации по
безопасности

- Ознакомьтесь с общими указаниями во избежание травматизма при работе на крыше:
- Обезопасьте строительную площадку на случай падения используемого материала / инструмента.
- При монтаже соблюдайте основные принципы из области строительной физики, такие как тепло-, паро-, гидро- и звукоизоляция.
- Цифры на рисунках показывают последовательность их монтажа!
- Производитель оставляет за собой право на внесение изменений.

⚠ Работы с несущими конструкциями здания и любые изменения в них могут производиться только квалифицированным персоналом!

В районах с обильными снегопадами поверх окна должно быть установлено снегозадерживающее устройство.

Для монтажных реек должна использоваться древесина первого сорта. Высота обрешетки (контрбруса) и высота монтажных реек должна быть одинаковой!

Eesti
Näpunäited/ohutusjuhend

- Katusel töötades tuleb pidada kinni üldistest ohutustehnika eeskirjadest.
- Kaitsta objekt ülevalt kukkuda võivate materjalide ja tööriistade eest.
- Paigalduse käigus pidada kinni ehitusfüüsika põhialustest: lengiümbruse soojusisolatsioon, veekindlus, aurutõke seestpoolt, heliisoatsioon.
- Numbrid juhise pildidel näitavad paigaldusetappe järjekorda!
- Tootja jätab endale õiguse tehniliste muudatuste sisseviimiseks.

⚠ Katuse kandekonstruktsioone võivad muuta ainult vastavat kvalifikatsiooni omavad töötajad!

Lumerikastes piirkondades tuleb monterida akna kohale lumepüüdur.

Akna paigalduslattidena kasutada ainult 1. klassi puitu. Roovlattide ja akna paigalduslattide paksum peab olema võrdne!

Latvija
Norādījumi/drošības norādījumi

- Jāievēro vispārējie drošības darba pasākumi pie jumta darbiem.
- Nodrošināt, lai celtniecības vietu neapdraud krītošas konstrukcijas vai priekšmeti.
- Veicot montāžu jāievēro fizikas pamatlūkumi, tādi kā: termoizolācija, aizsardzība pret mitrumu, nodrošinājums pret lietu un skaņas izolācija.
- Cipari norāda montāžas secību.
- Pieļaujamas tehniskas izmaiņas.

⚠ Jebkādas uzlabojumus nesošajās konstrukcijās var veikt tikai kvalificēti darbinieki!

Reģionos ar lielu sniega daudzumu virs loga ir jāuzmontē sniega savācējs.

Montāžai lietot tikai pirmšķirīgas kvalitātes koka latas. Latām jumta latojumā jābūt vienādā biezumā!

Lietuva
Nurodymas/saugumo taisyklės

- Būtina imtis bendrų darbo saugumo priemonių.
- Apsaugoti darbo vietą nuo krantinių elementų.
- Laikytis statybiniių normų reikalavimų šilumos izoliacijai, drėgmės izoliacijai, nepralaidumo lietaus vandeniui, garso izoliacijai.
- Skaičiai paveikslėliuose parodo montavimo eiliškumą.
- Galimi techniniai pakeitimai.

⚠ Bet kokius pakeitimus lango konstrukcijoje gali atlikti tik kvalifikuotas personalas!

Vietovėse, kuriose vyrauja sniegingos žiemos, virš lango būtina pritvirtinti sniego sulaikymo užtvaras.

Jeigu, montuojant stogo langus, neužtenka atstumo tarp gegnių, stogo konstrukcijos perdarymas galimas tik iš tokios pat medienos kaip ir gegnė!

Česká republika
Doporučení/bezpečnostní
upozornění

- Dodržujte všeobecné bezpečnostní předpisy pro práci na střeše.
- Zajistěte staveniště proti případnému pádu dílů.
- Respektujte stavebně-fyzikální podklady týkající se tepelné izolace, ochrany proti vlhkosti, vodotěsnosti při dešti a sněžení a ochraně proti hluku.
- Čísla vždy vyjadřují posloupnost jednotlivých kroků montáže!
- Technické změny vyhrazeny.

⚠ Zásahy do nosné konstrukce střechy mohou provádět jen kvalifikovaní pracovníci!

Ve sněhových oblastech je zapotřebí namontovat nad oknem zařízení k zachycení sněhu.

Pomocné montážní latě musejí být ze dřeva bez suků a prasklin. Výška střešních latí a pomocných montážních latí musí být stejná!

Slovenská republika **Pokyny/bezpečnostné upozornenie**

- Dodržiavajte všeobecné bezpečnostné predpisy pre prácu na streche.
- Zabezpečte stavenisko proti prípadnému pádu dielcov.
- Rešpektujte stavebno-fyzikálne podklady týkajúce sa tepelnej izolácie, ochrany proti vlhkosti, vodotesnosti pri daždi a snežení a ochrany proti hluku.
- Čísla vždy vyjadrujú postupnosť jednotlivých krokov montáže!
- Technické zmeny vyhradené.

⚠ Zásahy do nosnej konštrukcie strechy môžu vykonávať len kvalifikovaní pracovníci!

V oblastiach, kde často sneží, je nutné nad okno namontovať zariadenie na zachytávanie snehu.

Pomocné montážne laty musia byť z dreva bez uzlov a prasklín. Výška strešných lát a pomocných montážnych lát musí byť rovnaká!

Magyar Köztársaság **Utasítások/Biztonsági előírások**

- A tetőfedő munkáknál figyelembe kell venni a balesetvédelmi előírásokat.
- Biztonsági a beépítés helyszínét, hogy az esetlegesen lehulló hulladék, illetve egyéb anyagok ne okozzanak balesetet.
- Vegyék figyelembe az épületfizikai alapokat, így a hőszigetelést, nedvességvédelmet, vízzáróságot és zajvédelmet.
- A számok mindig a szerelés sorrendjét mutatják.
- Műszaki változtatások jogát fenntartjuk.

⚠ A tartószerkezetekhez csak képzett szakemberek nyúlhatnak hozzá!

Ahol gyakran havazik, az ablak felett hófogókat kell felszerelni.

A lécezéshez csak csomó és repedésmentes fát szabad felhasználni. A tetőlécnek és a segédlécnek magassága megegyező legyen!

Slovenija **Navodila**

- Upoštevejte splošne predpise za varnost na strehi.
- Zavarujte gradbišče pred padajočimi deli s strehe.
- Upoštevejte gradbeno fizikalne osnove, kot so toplotna izolacija, zaščita pred vlago, varnost pred vdorom dežja/vode in zaščita pred hrupom.
- Številke vedno kažejo vrstni red vgradnje!
- Pridržujemo si pravico do tehničnih sprememb.

⚠ Posege na nosilni konstrukciji smejo izvajati le kvalificirani strokovnjaki!

Na področjih z veliko snega se mora iznad okna montirati lovilnik snega.

Za vgradne letve uporabljajte le les vrste S 13. Višina strešnih letev in vgradnih letev mora biti enaka!

Italia **Consigli/Indicazioni di sicurezza**

- Durante i lavori sul tetto osservare le norme antinfortunistiche generali.
- Assicurare il luogo di lavoro contro la possibile caduta di pezzi.
- Osservare i principi fondamentali fisici di costruzione quali l'isolamento termico, l'isolamento per l'umidità, la protezione contro l'acqua piovana/impermeabilità all'acqua, la protezione acustica.
- I numeri indicano sempre la sequenza di montaggio!
- Escluse modifiche tecniche.

⚠ Gli interventi nelle strutture portanti devono essere eseguite solo dal personale specializzato!

In aree soggette a forti nevicate è necessario montare un dispositivo di raccolta della neve sopra la finestra.

Per le assicelle di montaggio utilizzare solo legno senza nodi ed incrinature. Le altezze dei listoni del tetto e le altezze delle assicelle di montaggio devono essere uguali!

Hrvatska/Bosna i Hercegovina **Napomene/sigurnosne napomene**

- Pridržavajte se općih propisa sigurnosti za radove na krovu.
- Osigurajte gradilište od dijelova koji mogu pasti s krova.
- Pridržavajte se građevinsko fizikalnih osnova kao što su toplinska izolacija, zaštita od vlage, sigurnost od prodora kiše/brtvljenje i zaštita od buke.
- Brojevi označavaju redoslijed kod montaže!
- Pridržano pravo tehničkih izmjena.

⚠ Radove na nosivim konstrukcijama smiju izvoditi samo kvalificirani stručnjaci!

U snijegom bogatim krajevima treba montirati uređaj za zaštitu od snijega iznad prozora.

Za ugradbene letve upotrebljavajte samo drvo 1. klase. Visina krovnih letava i visina ugradbenih letava mora biti jednaka!

Romania **Măsuri de siguranță**

- Respectați măsurile de siguranță valabile pentru lucrările pe acoperiș.
- Asigurați șantierul contra căderii oricărui obiecte de pe acoperiș.
- Respectați regulile impuse de fizica acoperișului cum ar fi : termoizolația, hidroizolația, protecția contra precipitațiilor, protecția contra umezelii și protecția fonică.
- Numerele reprezintă întotdeauna ordinea!
- Ne rezervăm dreptul a face schimbări din punct de vedere tehnic.

⚠ Lucrările legate de structura de bază/siguranță efectuate la acoperiș se execută numai de către personalul calificat.

În zonele bogate în ninsoare, deasupra ferestrei se va monta un dispozitiv de reținere a zăpezii.

Pentru stinghiile de fixare a se folosi numai lemni calitatea I . Înălțimea stinghiilor și al carioajului trebuie să fie egală.



■ Greece

Συμβουλή/σύσταση ασφαλείας

- Τηρήστε τα γενικά προληπτικά μέτρα ασφαλείας για τις εργασίες σε οροφές κτιρίων.
- Ασφαλίστε το εργαζόμενο από τυχόν πτώση αντικειμένων.
- Λάβετε υπόψη τις βασικές φυσικές κατασκευαστικές αρχές, όπως η θερμομόνωση, η προστασία από την υγρασία, η προστασία από τη βροχή/ η υδατοστεγανότητα και η αντιθρομβική προστασία.
- Οι αριθμοί αντιστοιχούν πάντα στη σωστή σειρά τοποθέτησης!
- Με την επιφύλαξη τροποποιήσεων.

⚠ Οι επεμβάσεις στη φέρουσα κατασκευή επιτρέπεται να πραγματοποιούνται αποκλειστικά από εξειδικευμένο προσωπικό!

Σε περιοχές με πολύ χιόνι πρέπει να τοποθετηθεί μια διάταξη συγκράτησης/έκτροπής του χιονιού επάνω από το παράθυρο.

Για τις δοκούς τοποθέτησης χρησιμοποιήστε αποκλειστικά ξύλο της κατηγορίας ταξινόμησης S 13. Το ύψος των δοκών της οροφής και το ύψος των δοκών τοποθέτησης πρέπει να είναι το ίδιο!



- DE Designo Wohnsicherheitsausstieg (WSA)
- EN Designo Top-hung and side-hung emergency escape (WSA)
- FR Accès toiture de sécurité résidentielle (WSA)
- IT Uscita di sicurezza (WSA)
- PL Wyjście bezpieczeństwa z mieszkania (WSA)
- BG Обезопасен мансарден люк (WSA)
- CZ Bezpečnostní výlez (WSA)
- EE Turvakatuseluuk (WSA)
- ES Salida de seguridad para vivienda (WSA)
- GR Έξοδος κινδύνου (WSA)
- HR Krovni izlaz u slučaju nužde (WSA)
- HU Biztonsági kibúvó (WSA)
- LT Gyvenamosios patalpos atsarginis išlipimas (WSA)
- LV Jumta avārijas izejas lūka (WSA)
- NL Nood-dakuitgang (WSA)
- PT Saída de emergência (WSA)
- RO Ieșire de siguranță din mansardă (WSA)
- RU Окно с аварийным выходом (WSA)
- SK Bezpečnostný bytový výlez (WSA)
- SL Varnostni izhod na streho (WSA)

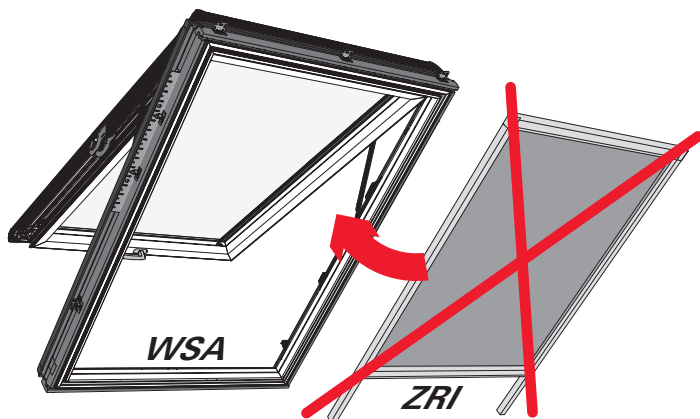

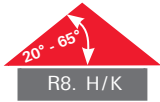

ZIN

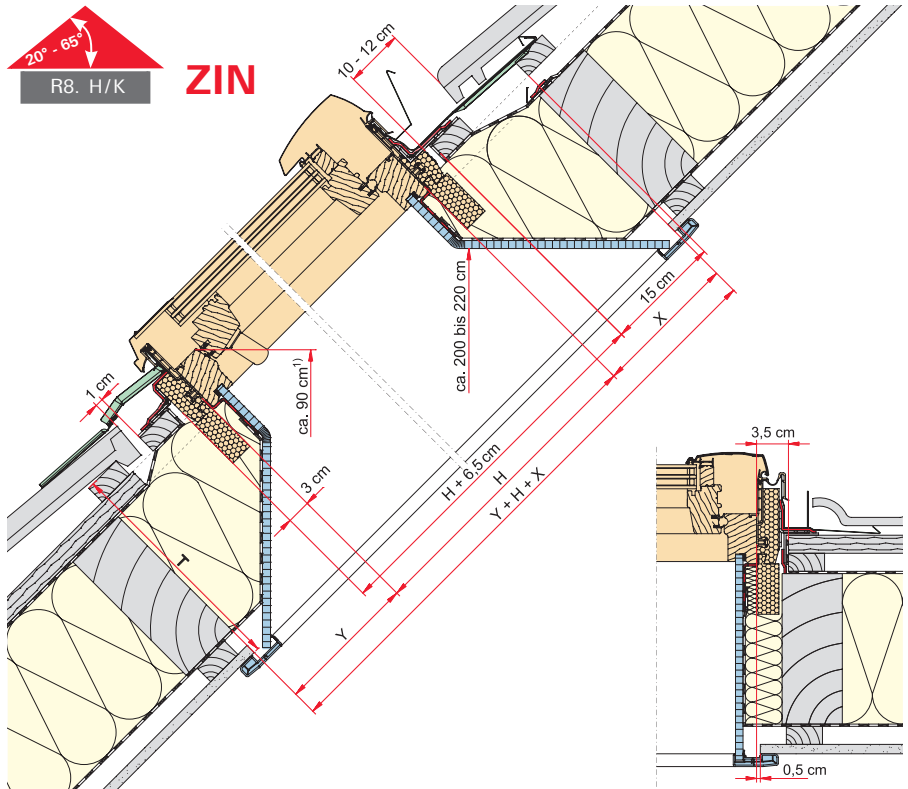

ZIN ▲		20°	25°	30°	35°	40°	45°	50°	55°	60°	65°
T = 26 cm	X	48	38	31	25	21	18	15	13	11	9
	Y	7	9	11	13	15	18	21	25	31	38
T = 28 cm	X	47	42	34	28	24	20	17	14	12	10
	Y	8	10	12	14	17	20	24	28	34	42
T = 30 cm	X	46	46	38	31	26	22	18	15	13	10
	Y	8	10	13	15	18	22	26	31	38	46
T = 32 cm	X	65	51	41	34	28	24	20	17	14	11
	Y	9	11	14	17	20	24	28	34	41	51
T = 36 cm	X	70	59	48	40	33	28	23	20	16	13
	Y	10	13	16	20	23	28	33	40	48	59
T = 40 cm	X	68	68	55	45	38	32	27	22	19	15
	Y	12	15	19	22	27	32	38	45	55	68



1

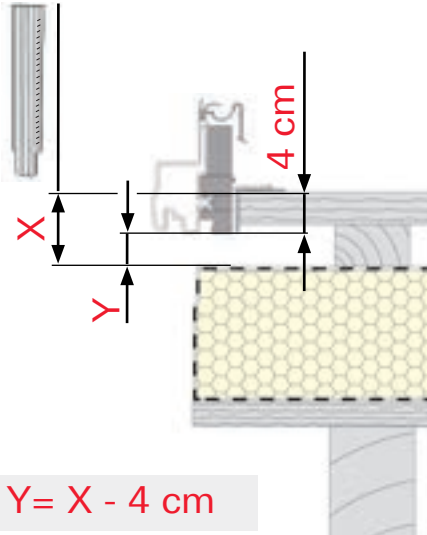

2

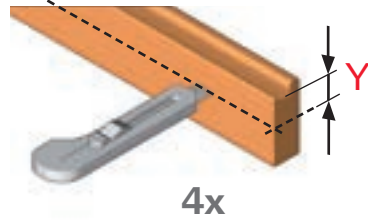

3

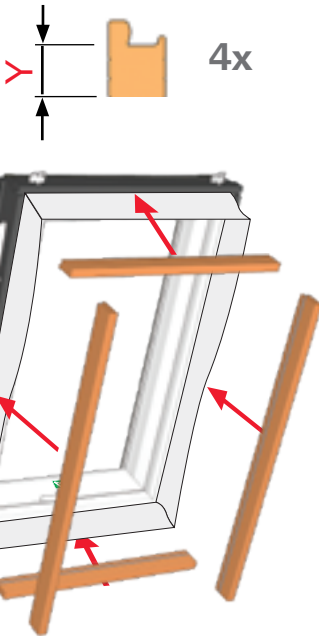

4

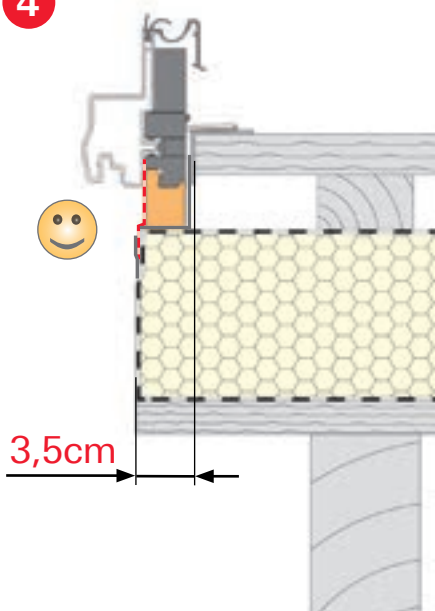

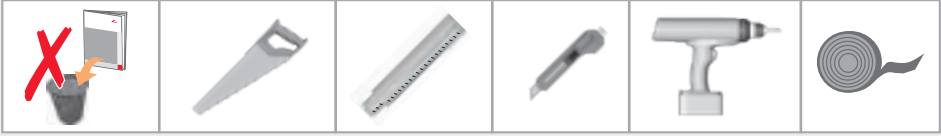

11/14
+

+
11/14

A

ø4,0 x30

B

C

D

R8. K WD	16	4	1	3
-----------------	----	---	---	---

11/14
+

+
11/14

A

ø4,0 x30

B

C

D

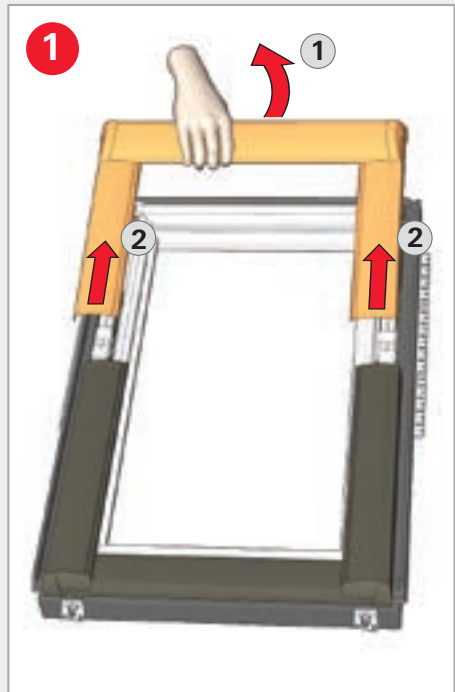
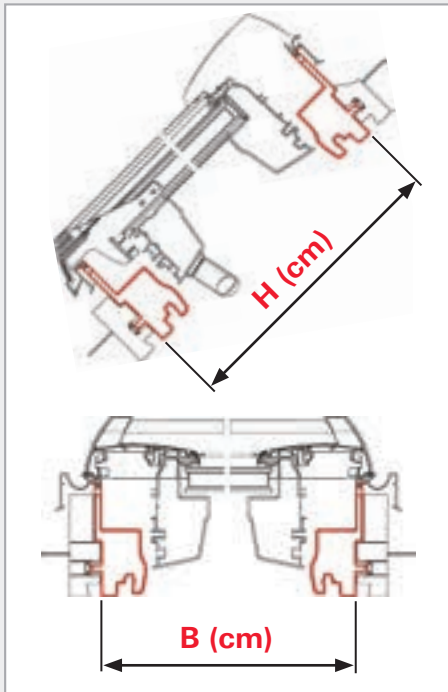
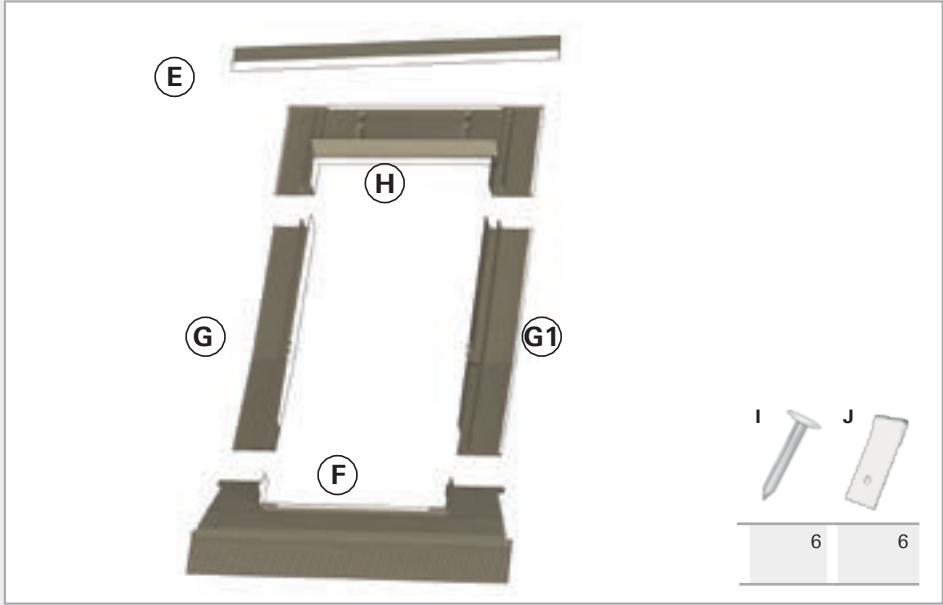

R8. H WD	16	4	1	3
-----------------	----	---	---	---

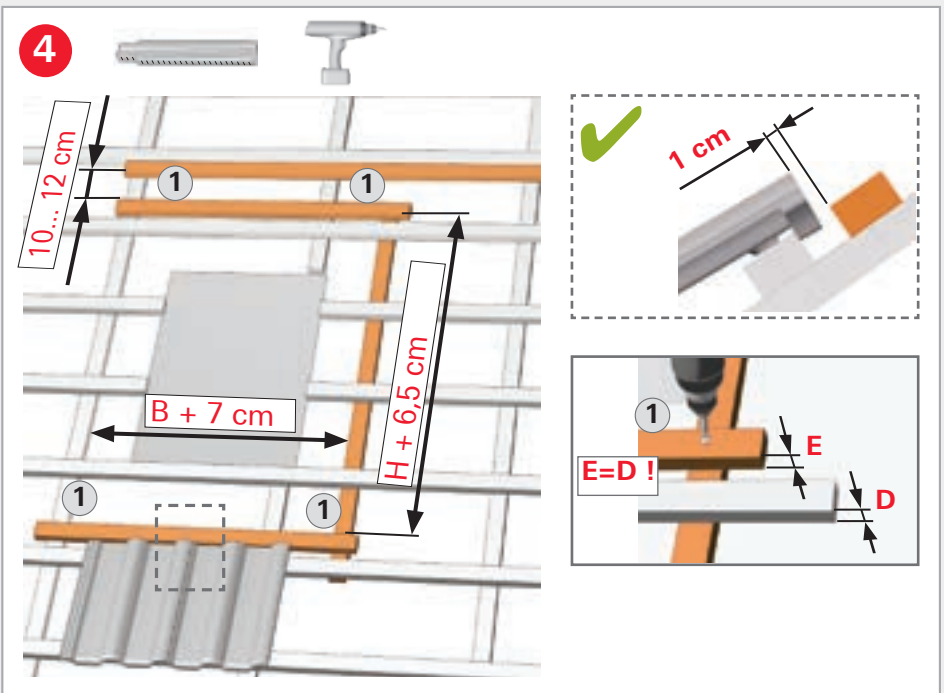
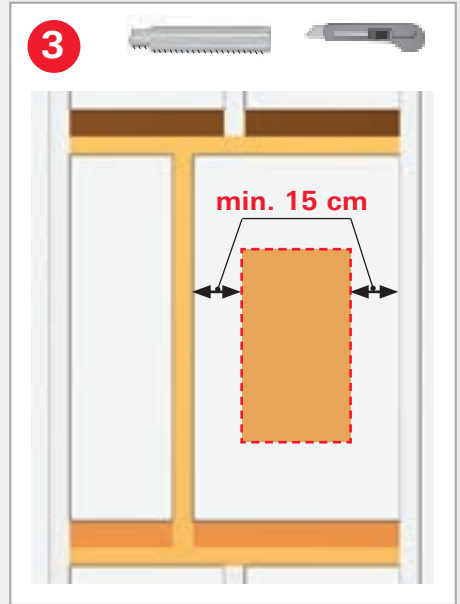
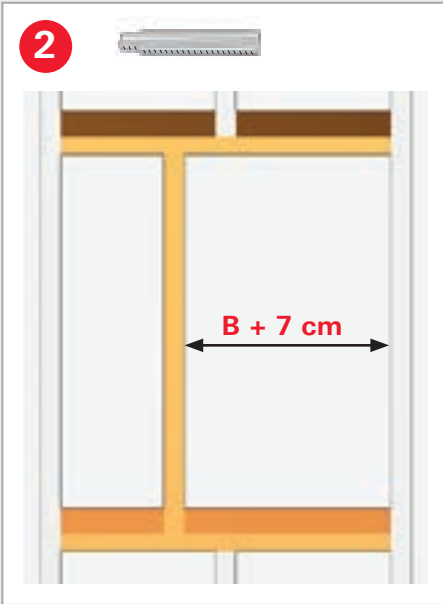

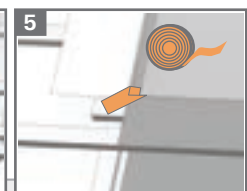
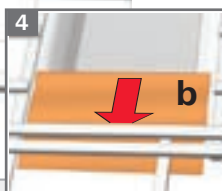
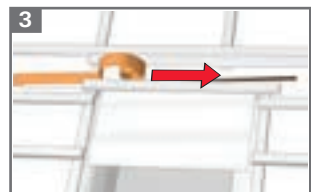
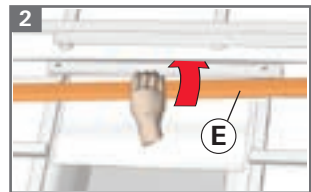
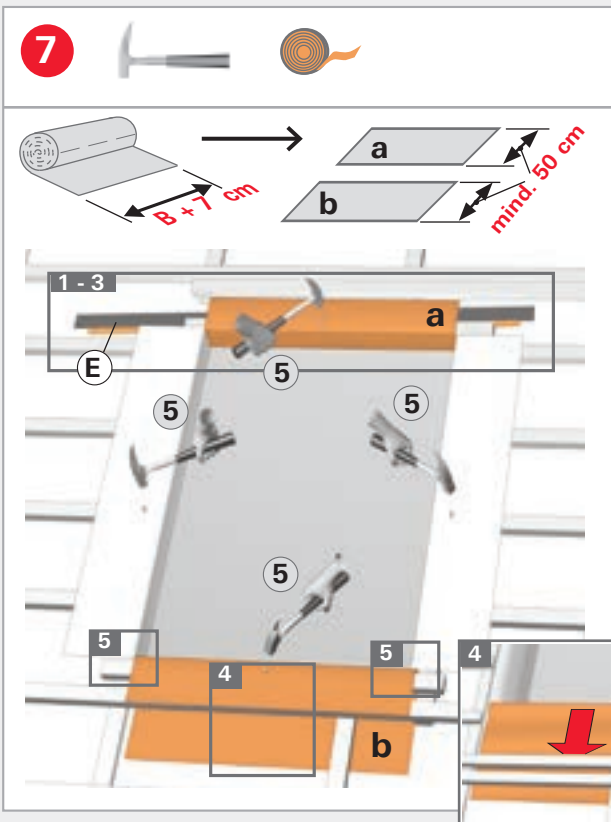
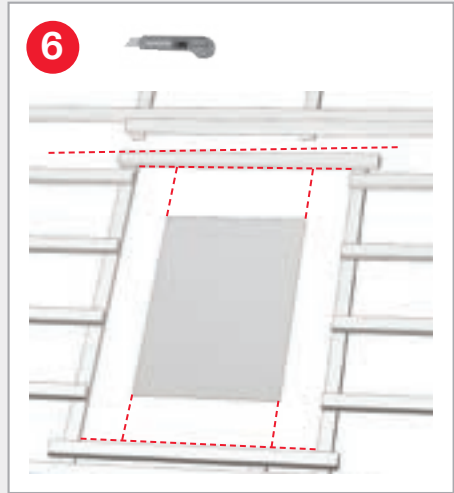

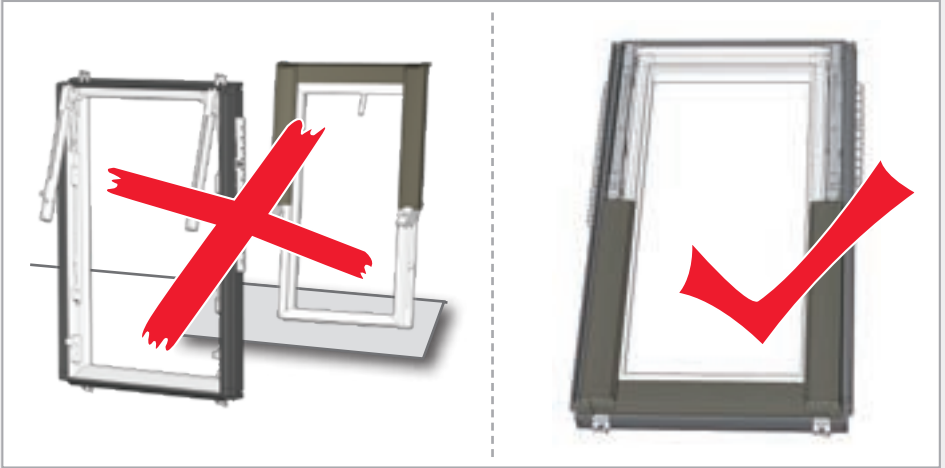



12   **A 4x**
 ø4,0 x30

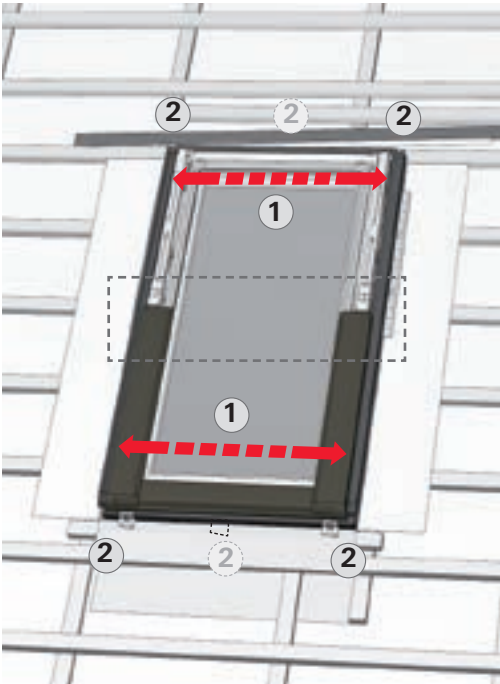
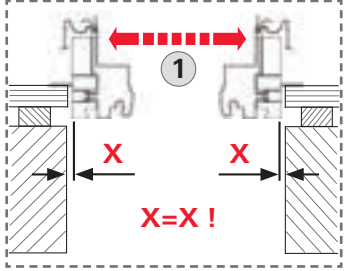
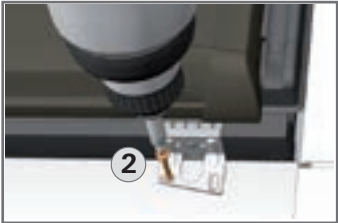



13

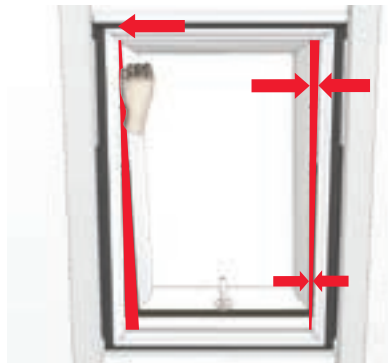
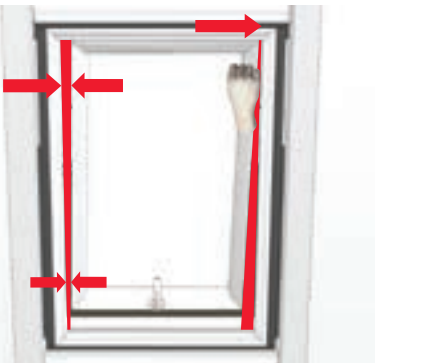
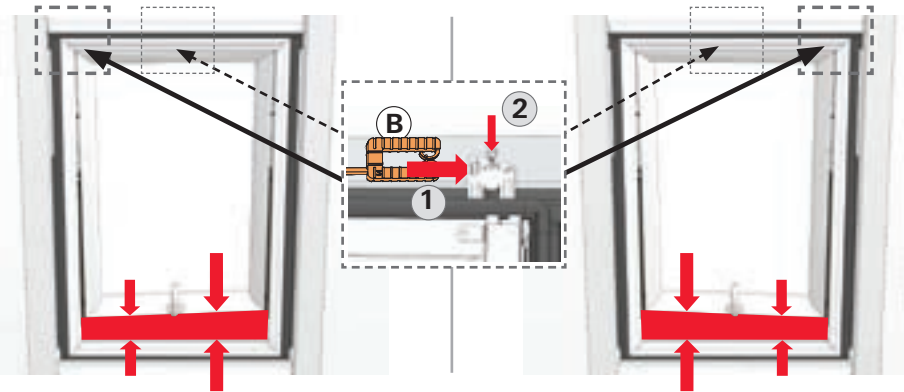
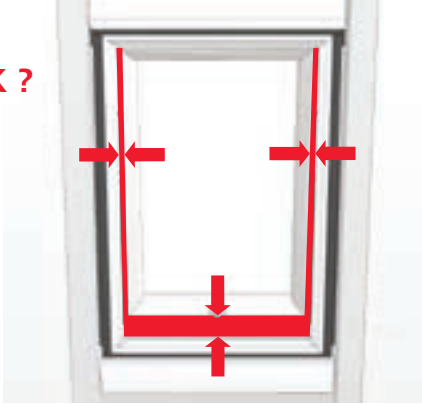

B

OK ?



14



A 4x
ø4,0 x30

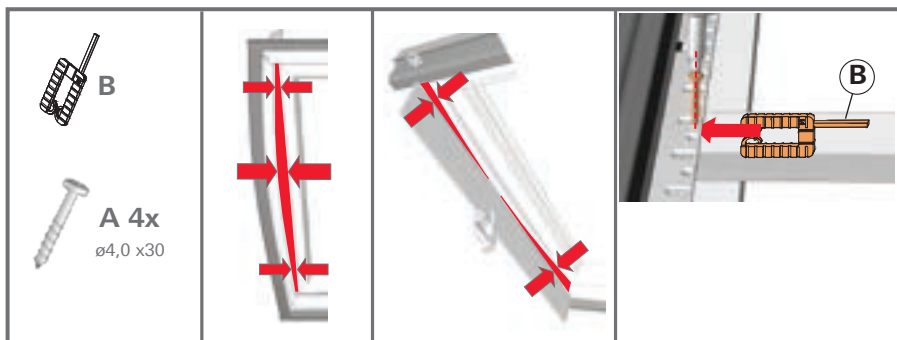
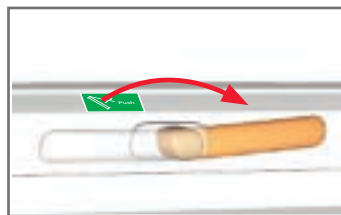
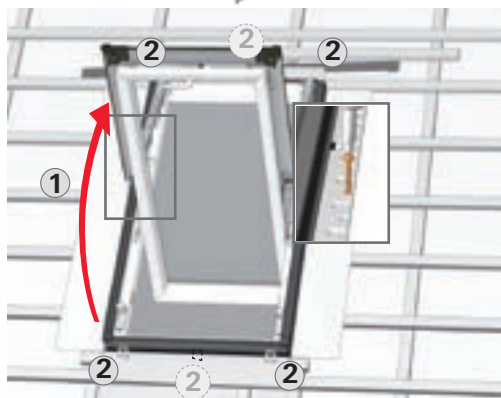

15

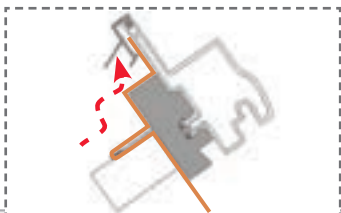
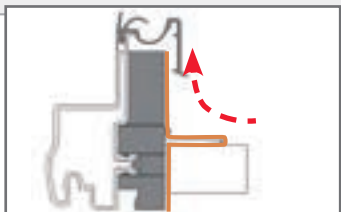
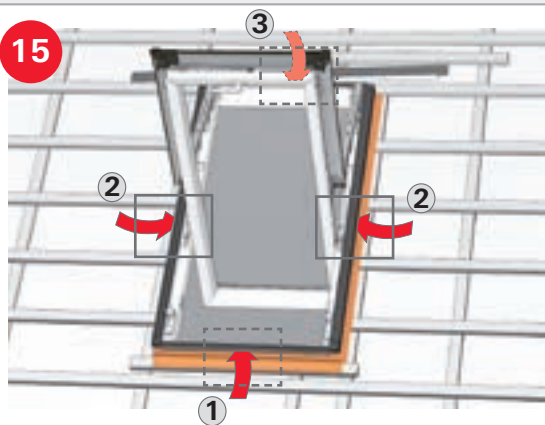

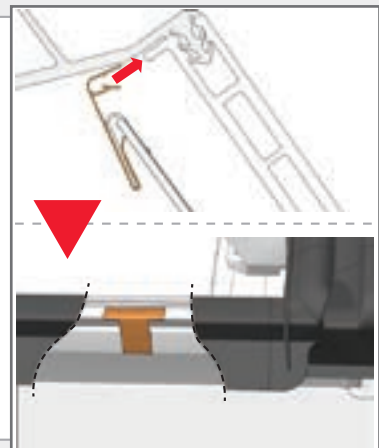
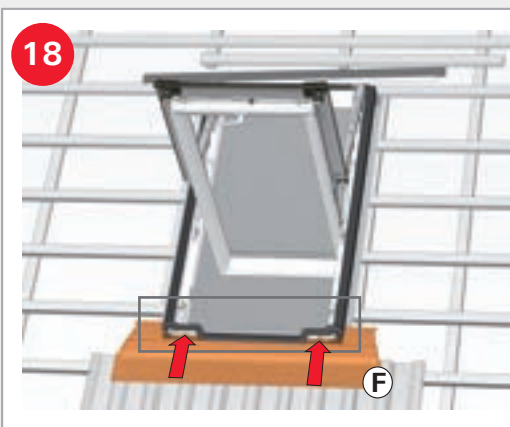
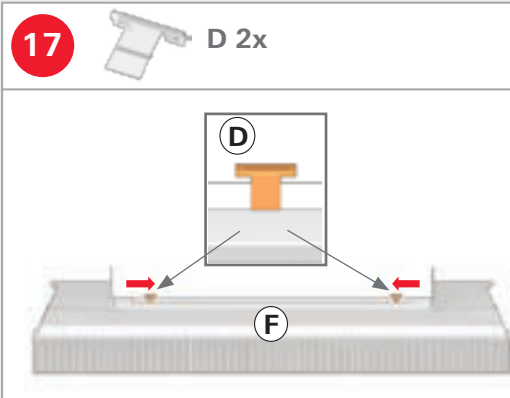
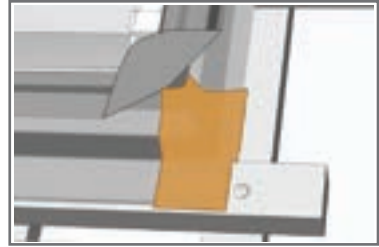
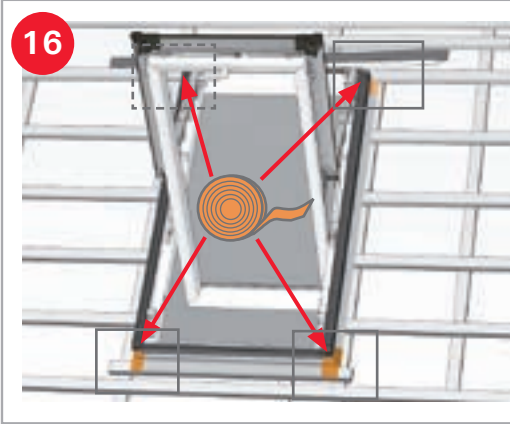

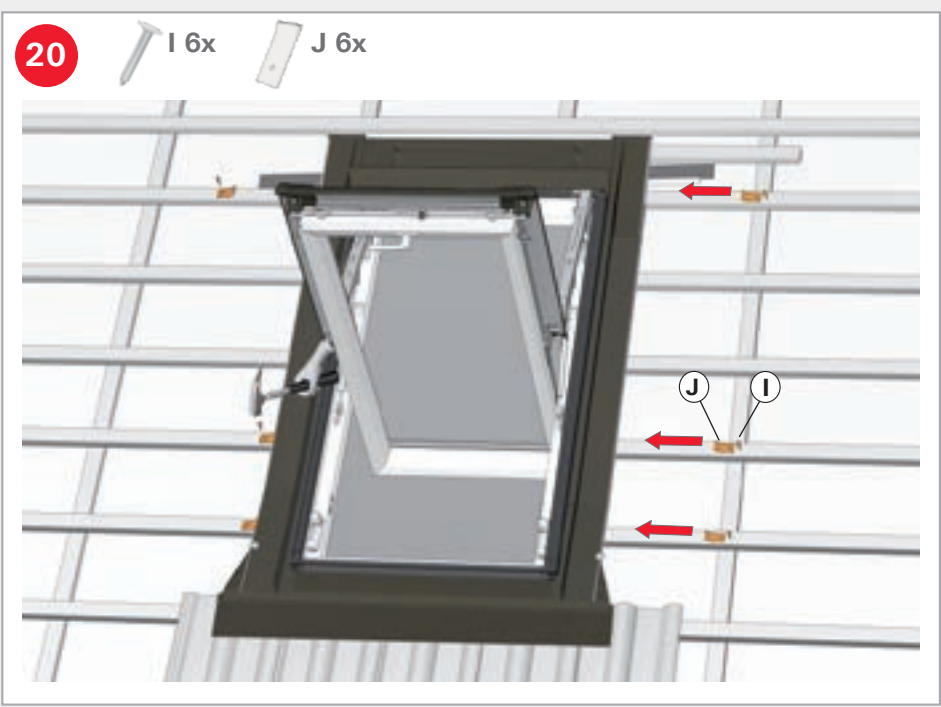
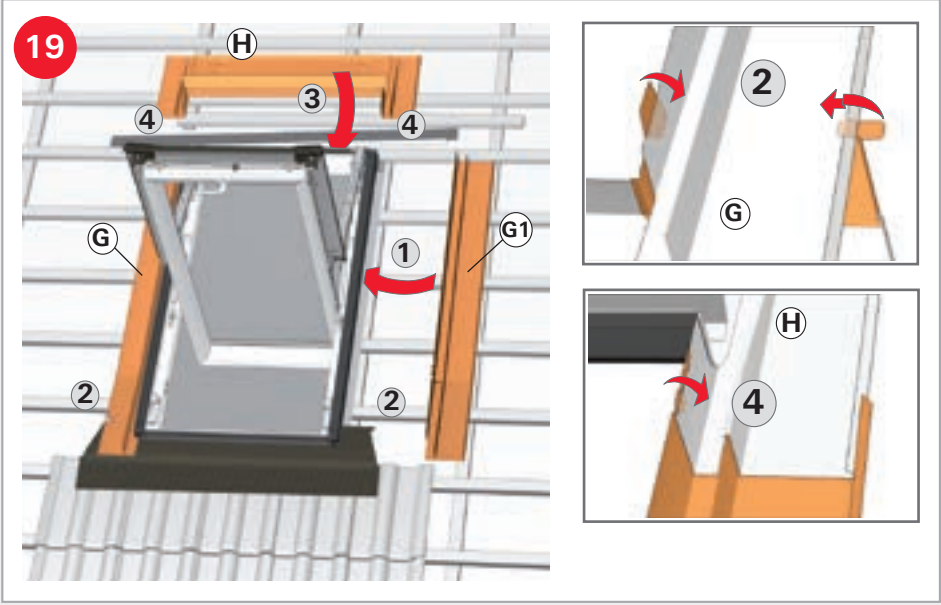

21

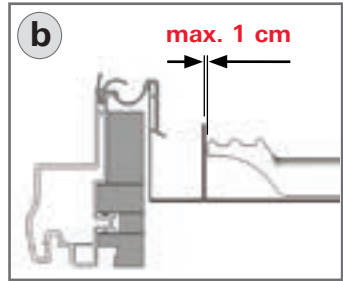
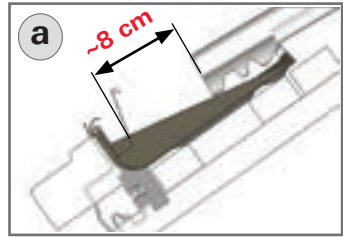
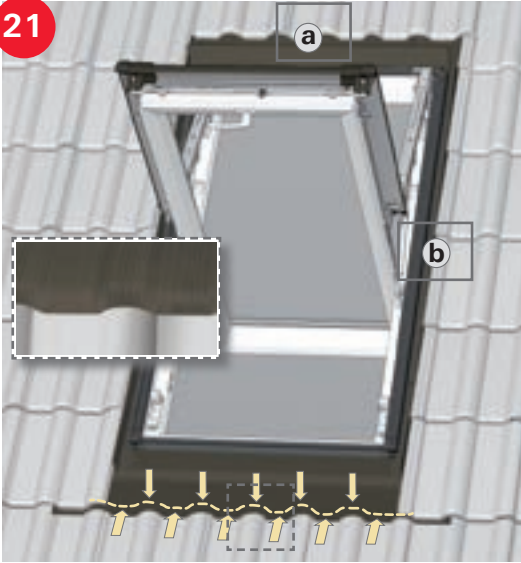

22

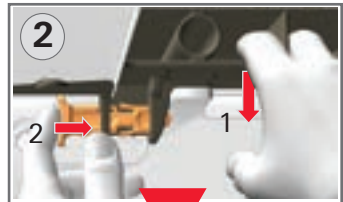

23

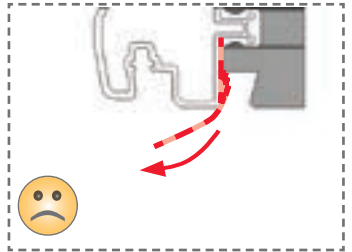
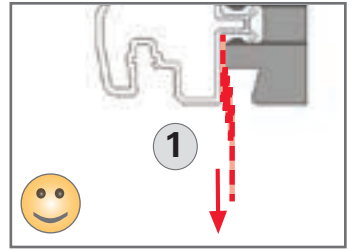
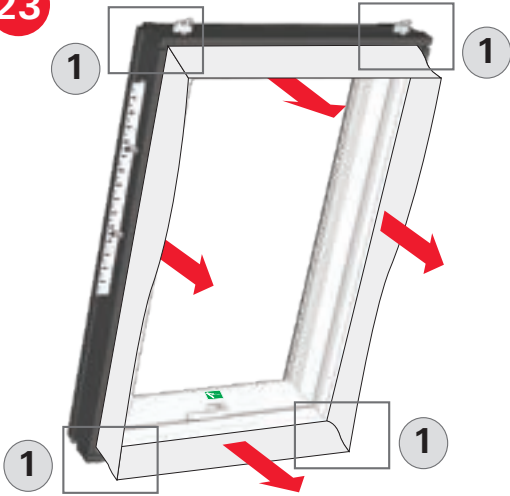



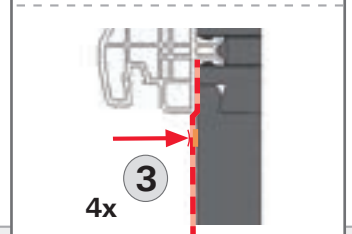
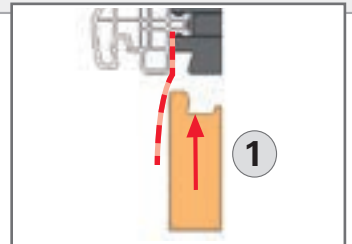
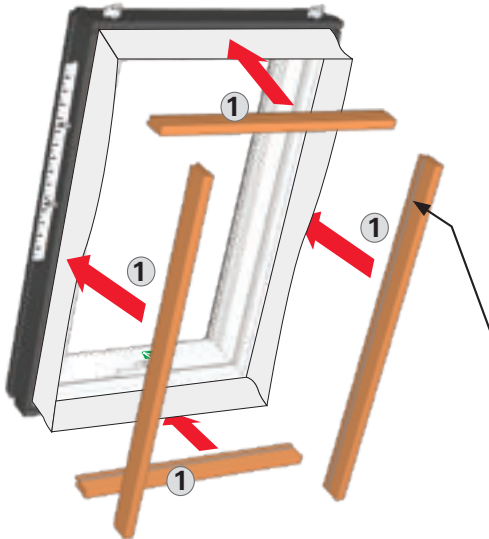



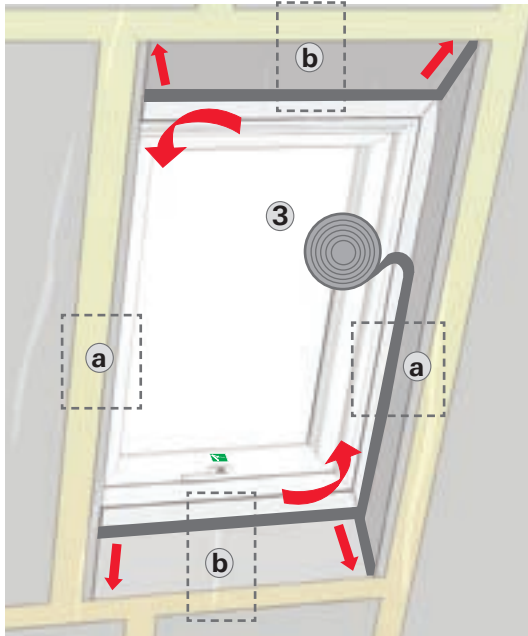













24



25





Einstellung Federkraft.

-  Flügel springt immer auf?
Feder auf beiden Seiten gleichmäßig entspannen!
-  Si l'ouvrant s'ouvre seul?
Diminuer la tension des ressorts de la même valeur des deux côtés!
-  If the sash is opening itself?
You need to reduce the tension of the springs on both sides!
-  Vleugel springt altijd open?
Veren aan beide zijden gelijkmatig ontspannen!
-  La hoja se abre siempre por si sola?
Relajar el muelle uniformemente en ambos lados!
-  Batente abrindo-se inadvertidamente?
Distender a mola do mesmo modo em ambos os lados!
-  Skrzydło zbyt intensywnie podnosi się?
Równomiernie po obu stronach poluzować sprężyny!
-  Ваша створка открывается слишком резко?
 Нужно уменьшить натяжение пружин с обеих сторон.
-  Kas Teie aken avaneb ise liialt palju?
Tuleb mõlemalt poolt raamivedrusid maha keerata!
-  Větrne viennēm atveras?
Viennēmīgi atlaist atsperes abās pusēs!
-  Varčia visada staiga pakyla?
Spyruokles atpalaiduoti. Tolygiai iš abiejų langų pusių!
-  Křídlo se samo otvírá?
Povolit pružiny stejnoměrně na obou stranách!
-  Křídlo sa samo otvára?
Na obidvoch stranách rovnako povoliť pružiny!
-  Az ablakszárny mindig kinyílik?
A rugót mind két oldalon egyenletesen meg kell lazítani!
-  Krílo se vedno odpre?
Vymet na obeh stranah enakomerno popustiti!
-  Se il battente si apre di scatto?
Allentare simmetricamente le molle su entrambi i lati!
-  Prozorsko krilo se samo otvara?
Ravnomjerno opustiti opruge s obje strane!
-  Fereastra se deschide de la sine?
Eliberați în aceeași măsură arcurile laterale!
-  Το πτερόγιο ανοίγει πάντοτε ξαφνικά?
Σφίξτε το ελατήριο και στις δύο πλευρές ομοιόμορφα!

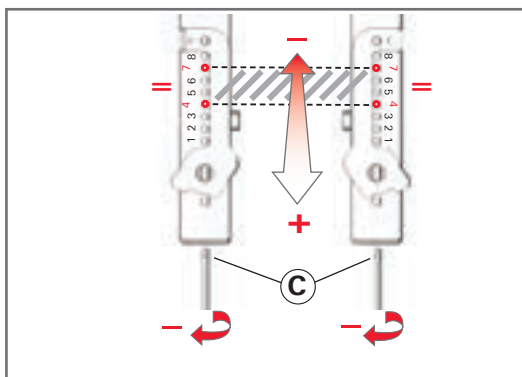
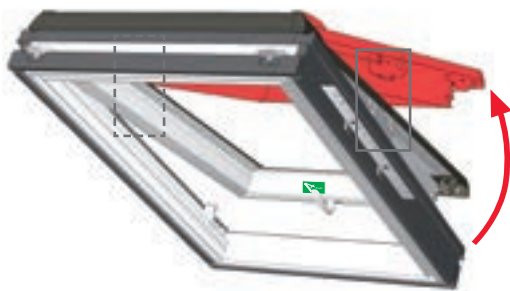
✓ C 1x





 Flügel fällt immer zu?
Feder auf beiden Seiten gleichmässig spannen!

 Si l'ouvrant retombe?
Diminuer la tension des ressorts de la même valeur des deux côtés!

 If the sash is closing itself?
You need to improve the tension of the springs on both sides!

 Vleugel valt altijd open?
Veren aan beide zijden gelijkmatig ontspannen!

 La hoja se cierra siempre por si sola?
Tensor el muelle uniformemente en ambos lados!

 Bateinte fechando-se inadvertidamente?
Tender a mola do mesmo modo em ambos os lados!

 Skrzydło ciągle opada?
Równomiernie po obu stronach naciągając sprężyny!

 Ваша створка не держится в открытом положении и/или самостоятельно закрывается?
Нужно увеличить натяжение пружин с обеих сторон.

 Kas Teie aken ei püsi avatuna?
Tuleb mõlemalt poolt raamivedrusid pingutada!

 Vērtne vienmēr aizveras?
Vienmērīgi nospriegot atsperes abās pusēs!

 Varčia pati užsidaro?
Spyruokles įtempti. Tolygiai iš abiejų labgą pasių!

 Křídlo se samo zavírá?
Pružiny na obou stranách stejnoměrně napnout!

 Křídlo sa samo zavára?
Na obidvoch stranách rovnako nastaviť pružiny!

 Az ablakszárny mindig becsukódik?
A rugókat mindkét oldalon egyenletesen meg kell lazítani!

 Krilo se vedno zapre?
Vymet na obeh straneh enakomerno napnite!

 Se il battente si chiude di scatto?
Registrare simmetricamente le molle su entrambi i lati!

 Prozorsko krilo se samo spušta?
Ravnomjerno zategnuti opruge s obje strane!

 Fereastra se închide de la sine?
Înșurubați în aceeași măsură arcurile laterale!

 Το περὺνιο ανοίγει πάντοτε ξαφνικά?
Σφίξτε το ελατήριο και στις δύο πλευρές ομοίωμα!

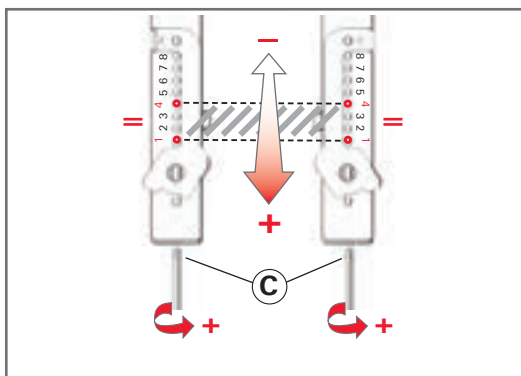
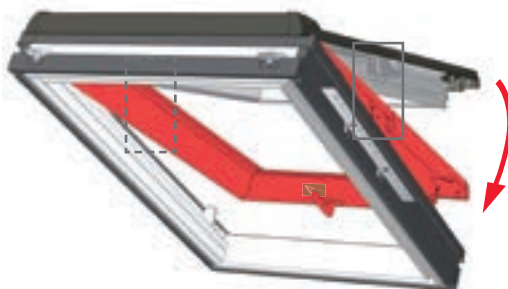

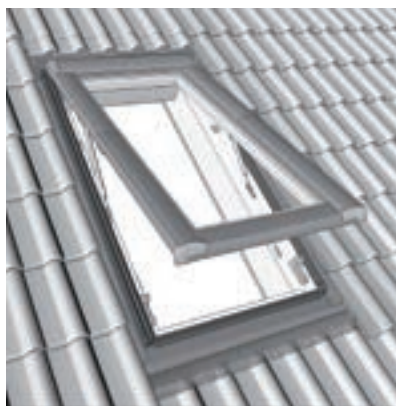
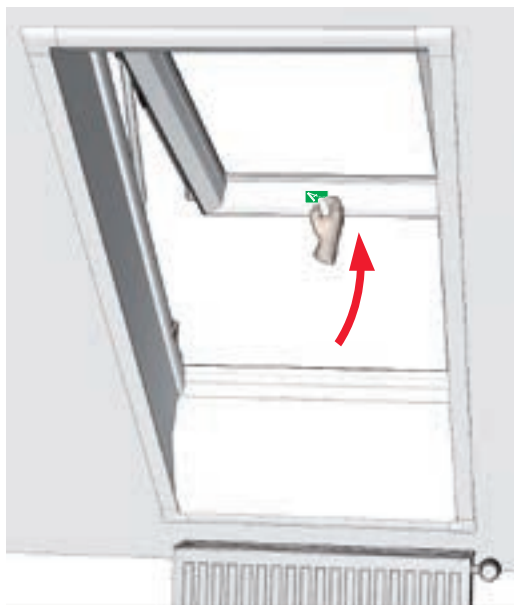

Flügel maximal öffnen.

-  Normale Öffnungsweite
-  Largeur d'ouverture normale.
-  Normal opening width.
-  Normale openingsbreedte.
-  Ángulo de apertura normal.
-  Amplitude de abertura normal.
-  Normalna szerokość otwarcia.
-  Нормальная ширина раскрытия.
-  Tavaline avamisulatus.
-  Standarta atvēruma platums.
-  Normalaus atidarymo riba.
-  Běžná šířka otevření.
-  Normálna šírka pri otvorení.
-  Normális nyílásméret.
-  Normalna velikost odprtine.
-  Ampiezza d'apertura normale.
-  Normalna širina otvaranja.
-  Lărgime de deschidere normală.
-  Κανονικό πλάτος του ανοίγματος.





 Flügel nach Haltepunkt überdrücken bis Ausstiegsöffnung von ca. 125 cm erreicht ist.

 Une fois la fenêtre en position de projection, pousser l'ouvrant pour arriver à une ouverture d'environ 125 cm.

 Push the sash right through to the stop point until an escape opening of about 125cm is achieved.

 Wanneer het venster in uitzetstand staat, kan u het raam verder openduwen tot een opening van ongeveer 125 cm.

 Continuar empujando la hoja más allá del punto de retención hasta alcanzar una apertura de salida de aprox. 125 cm.

 Forçar a janela a abrir-se para lá do ponto de imobilização até alcançar uma abertura de saída correspondente a aprox. 125 cm.

 Przepchnąć skrzydło okienne poza punkt podparcia do momentu aż uzyskany zostanie otwór wyjściowy ok. 125 cm.

 Протолкнүть оконную створку за точку опоры до момента, когда появится выходное отверстие около 125 см

 Lükata aknaluuk tugipunktist väljapoole kuni umbes 125 cm suuruse väljapääsua-vause tekkimiseni.

 Aizbīdīt loga vērtņi pāri atbalsta punktam, līdz tiek iegūta izeja ar atveri apm. 125 cm.

 Lango sávarát pastumti už atamos taško iki atsiranda apie 125 cm išėjimo anga.

 Křídlo zatlačte do krajní polohy, až dosáhnete otevření výlezu na ca 125 cm.

 Křídlo zatlačte do krajnej polohy, až sa dosiahne otvorenie výlezu na cca 125 cm.

 Ablakszárnyat a tartópontokon túl kell nyomni, addig amíg kb. 125 cm-es nyitást el nem érjük.

 Krilo potisnite preko točke zaustavitve, dokler izhodna odprtina ne znaša približno 125 cm.

 Premere il battente verso il punto di arresto fino ad ottenere un'apertura di uscita di ca. 125 cm.

 Krilo pritisnuti dalje od položaja držanja tako da se stvori otvor za izlaženje od oko 125 cm.

 Apăsati aripa spre punctul de susținere, până când se atinge o deschidere de ieșire de cca. 125 cm.

 ώσπου να επιτευχθεί ένα άνοιγμα εξόδου περίπου 125 εκ.

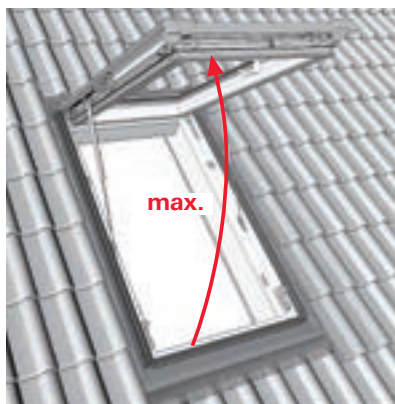
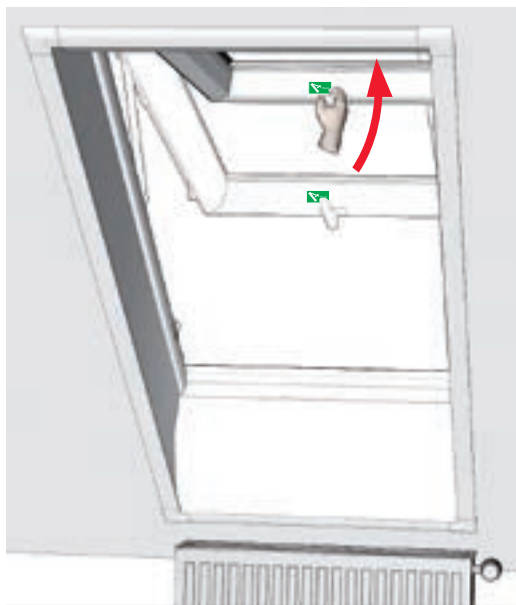



The roof window.



www.roto-contacts.com



www.roto-extra.com

Roto Frank DST Vertriebs-GmbH
Wilhelm-Frank-Straße 38-40
97980 Bad Mergentheim
Deutschland

